

Non è permesso consegnare a terzi o riprodurre questo documento né, utilizzare il contenuto o renderlo comunque noto a terzi senza la nostra autorizzazione esplicita. Ogni infrazione comporta il risarcimento dei danni subiti. E' fatta riserva di tutti i diritti derivati da brevetti o modelli.

PROGETTO
BANCA DIS.
TIPICO

Free2move eSolutions S.p.A.

Piazzale Lodi, 3 - 20137 - Milano - Italy

Via Livorno, 60 - 10144 - Torino - Italy

www.esolutions.free2move.com



| | | | | | | | | | | | | | | |
|------|----------|------|-------|---------|------------|--------------------------------------------------------------------------------------|---------------------------------------|---------|------|----------------------------------------------------------------------------------------------------|-----|---|------|---|
| | | | | DATA | 06/12/2022 |  | Free2move eSolutions | Wallbox | 0001 | <table border="1"> <tr> <td>FG.</td> <td>1</td> </tr> <tr> <td>F.S.</td> <td>2</td> </tr> </table> | FG. | 1 | F.S. | 2 |
| FG. | 1 | | | | | | | | | | | | | |
| F.S. | 2 | | | | | | | | | | | | | |
| | | | | DISEGN. | FN | electrical diagram | | | | | | | | |
| | | | | VISTO | AS,AC,CP | Cover | 0001 | | | | | | | |
| REV. | MODIFICA | DATA | FIRMA | APPR. | FF | | | | | | | | | |

| Disegno/File | Fg/Sh | Description |
|-------------------|-------|----------------------------------------|
| WALLBOX SCHEMATIC | 1 | Cover |
| | 2 | Index |
| | 3 | Single Wallbox One Line Diagram |
| | 4 | Single Wallbox RS 485 Schematic |
| | 5 | Multi Wallbox One Line Diagram |
| | 6 | Wallbox RS 485 Master-Slave Connection |
| | 7 | Multi Wallbox Safety Circuit |
| | 8 | |
| | 9 | |
| | 10 | |
| | 11 | |

| | | | | | | | | | | | | |
|------|----------|------|-------|---------|------------|--------------------------------------------------------------------------------------|---------------------------------------|----------------------------|---|------|-----------------|---|
| | | | | DATA | 06/12/2022 |  | Free2move eSolutions | Wallbox electrical diagram | | 0001 | | |
| | | | | DISEGN. | FN | | | Index | | | | |
| | | | | VISTO | AS,AC,CP | | | | | | | |
| REV. | MODIFICA | DATA | FIRMA | APPR. | FF | | | | | 0001 | FG. 2 F.S. 3 | |
| 0 | | 1 | | 2 | | 3 | 4 | 5 | 6 | 7 | 8 | 9 |

ELECTRICAL GRID

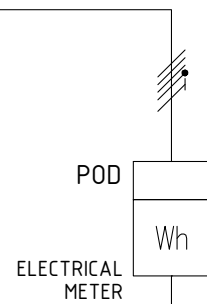

ELECTRICAL METER

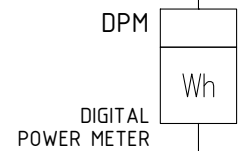

DPM
DIGITAL POWER METER

CB SIZE ON THE BASIS OF CUSTOMER NEEDS

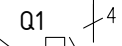

0,03 A CLASS A I_d

CIRCUIT BREAKER WITH RCD

SURGE PROTECTION DEVICE CIRCUIT (OPTIONAL)

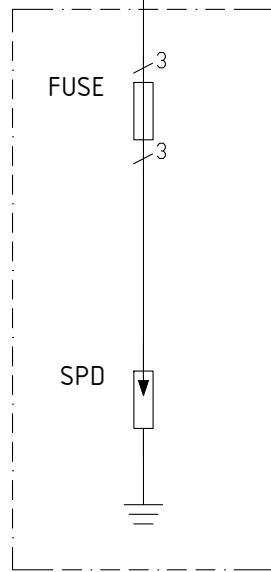

FUSE

SPD

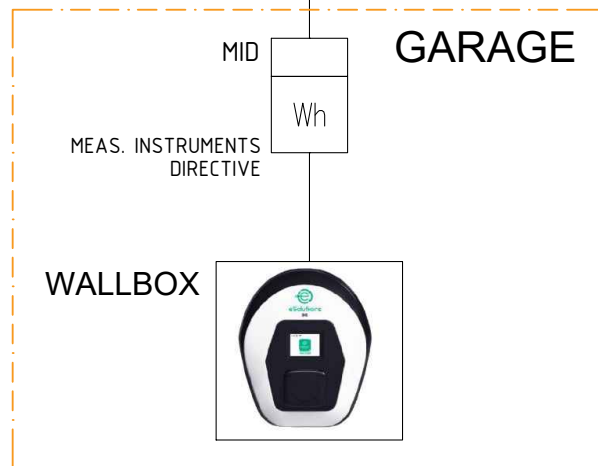

GARAGE

MID
MEAS. INSTRUMENTS DIRECTIVE

WALLBOX

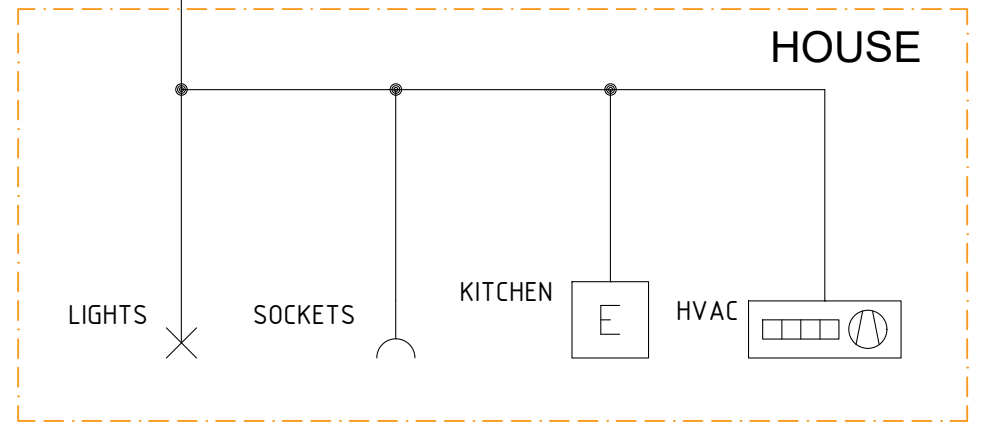

HOUSE

LIGHTS

SOCKETS

KITCHEN

E

HVAC

| | |
|---------|------------|
| DATA | 06/12/2022 |
| DISEGN. | FN |
| VISTO | AS,AC,CP |
| REV. | MODIFICA |
| DATA | FIRMA |
| APPR. | FF |



Free2move
eSolutions

Wallbox
electrical diagram
Single Wallbox One Line Diagram

0001

0001

FG. 3
F.S. 4

COLOUR LEGEND (BOTH OPTIONS):
 B+: BLUE
 A-: WHITE/BLUE
 GND: ORANGE

RS485 COMMUNICATION BETWEEN DEVICES

OPTION 1: GAVAZZI DPM AND MID

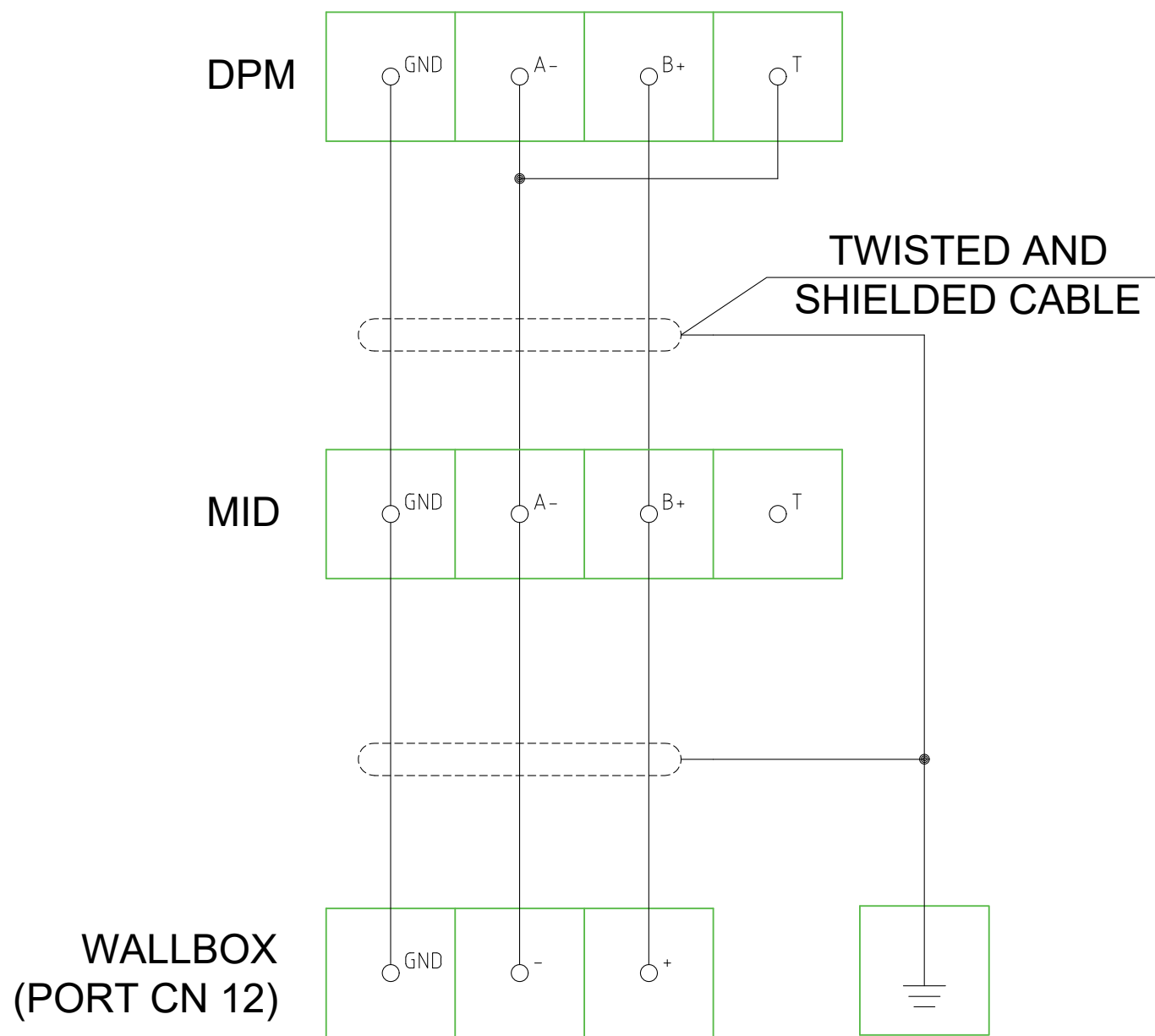

OPTION 2: FINDER DPM AND MID

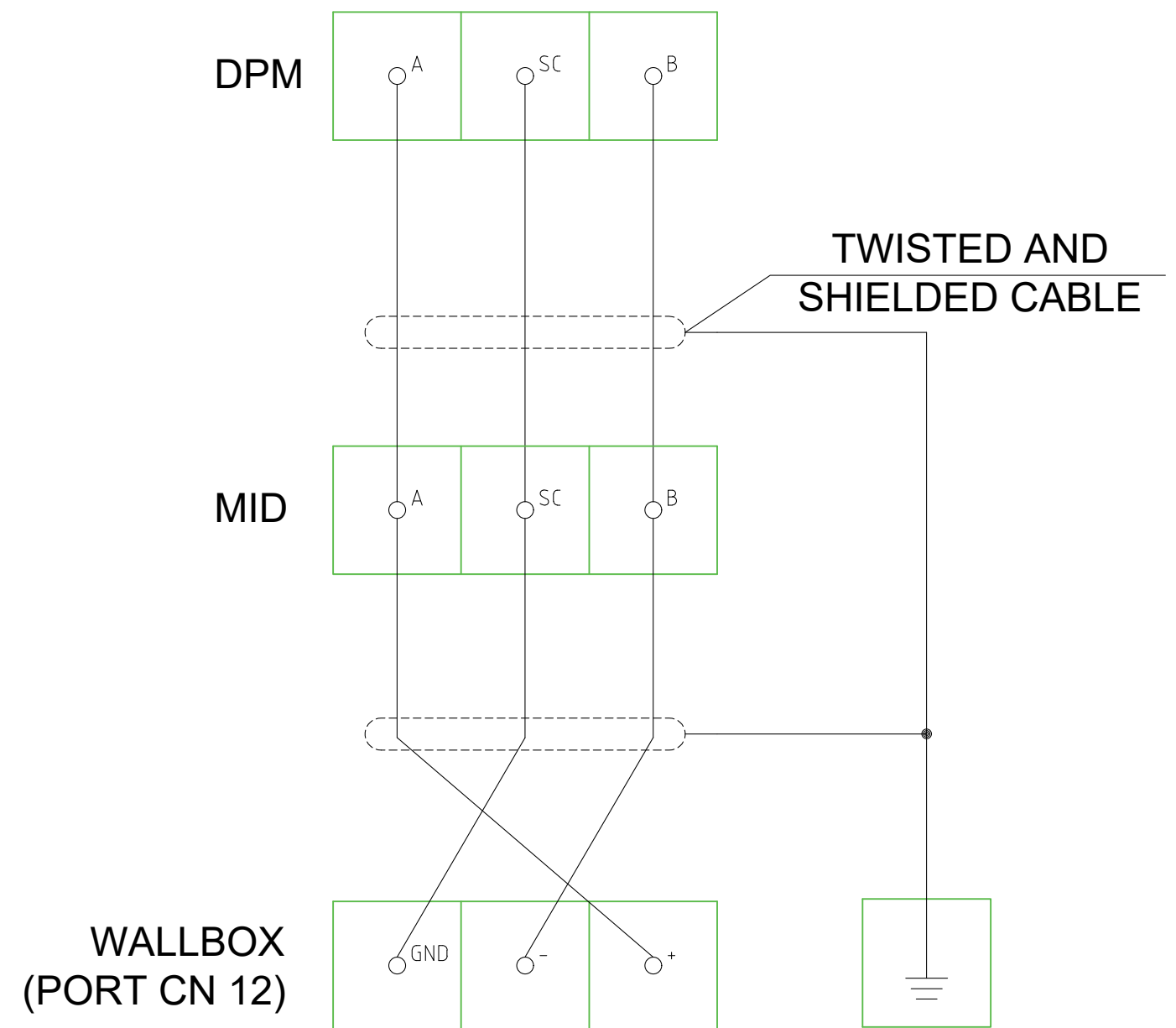

| | |
|---------|------------|
| DATA | 06/12/2022 |
| DISEGN. | FN |
| VISTO | AS,AC,CP |
| APPR. | FF |

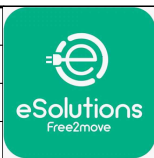

Free2move
eSolutions

Wallbox
electrical diagram
Single Wallbox RS 485 Schematic

0001

0001

| | |
|------|---|
| FG. | 4 |
| F.S. | 5 |

FROM
POD

CB SIZE ON THE BASIS
OF CUSTOMER NEEDS

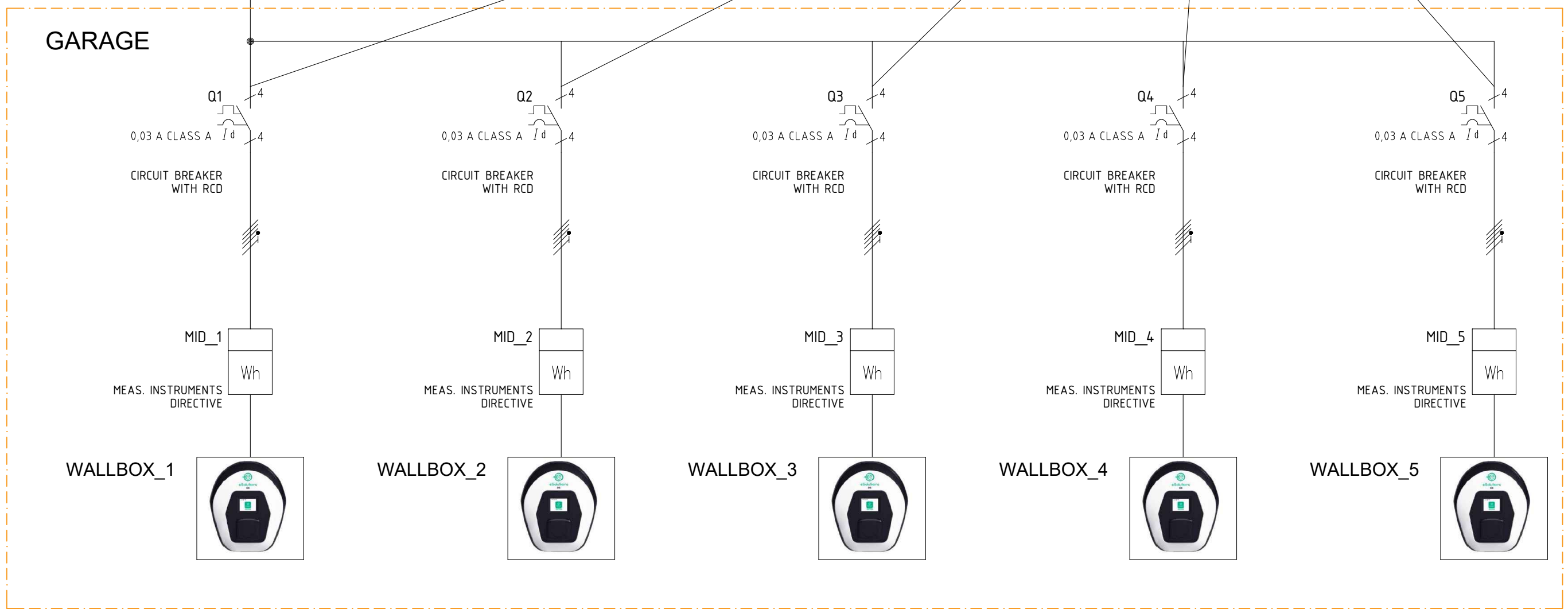

| | |
|---------|------------|
| DATA | 06/12/2022 |
| DISEGN. | FN |
| VISTO | AS,AC,CP |
| APPR. | FF |



Free2move
eSolutions

Wallbox
electrical diagram
Multi Wallbox One Line Diagram

| | |
|------|--------|
| 0001 | FG. 5 |
| 0001 | F.S. 6 |

RS485 COMMUNICATION BETWEEN DEVICES

COLOUR LEGEND:
 B+: BLUE
 A-: WHITE/BLUE
 GND: ORANGE

NOTE: FOR DETAILS CONCERNING DPM-MID-WALLBOX (PORT CN 12) RS 485 CONNECTION PLEASE REFER TO SHEET 4

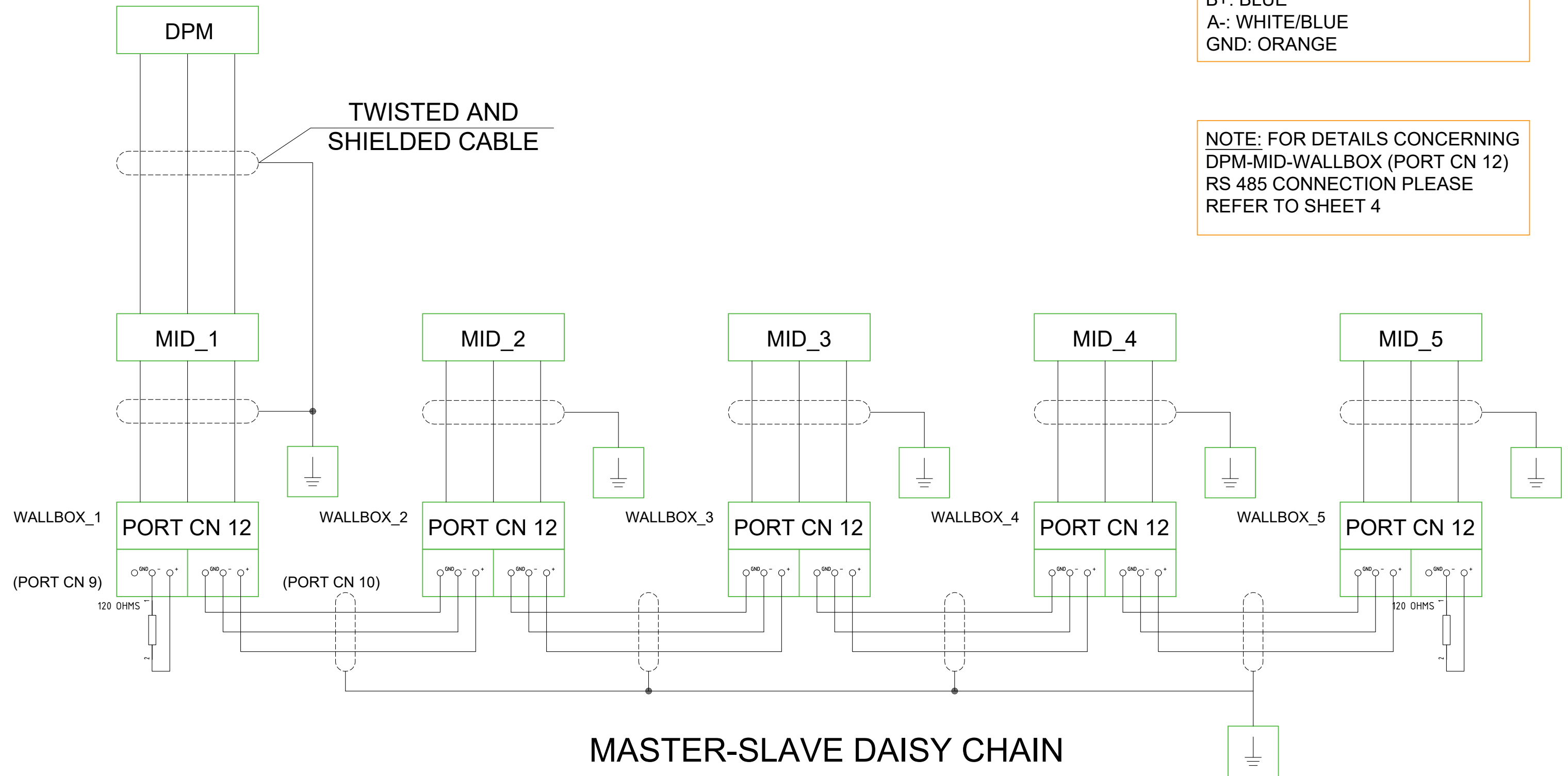

MASTER-SLAVE DAISY CHAIN

| | | | | | | | | | | | |
|------|----------|------|-------|---------|------------|--------------------------------------------------------------------------------------|---------------------------------------|----------------------------------------|--|--------|-------|
| | | | | DATA | 06/12/2022 |  | Free2move eSolutions | Wallbox electrical diagram | | 0001 | |
| | | | | DISEGN. | FN | | | Wallbox RS 485 Master-Slave Connection | | 0001 | |
| | | | | VISTO | AS,AC,CP | | | | | | FG. 6 |
| REV. | MODIFICA | DATA | FIRMA | APPR. | FF | | | | | F.S. 7 | |

SAFETY CIRCUIT EXAMPLE (NOT MANDATORY) FOR MULTI WALLBOX SYSTEMS

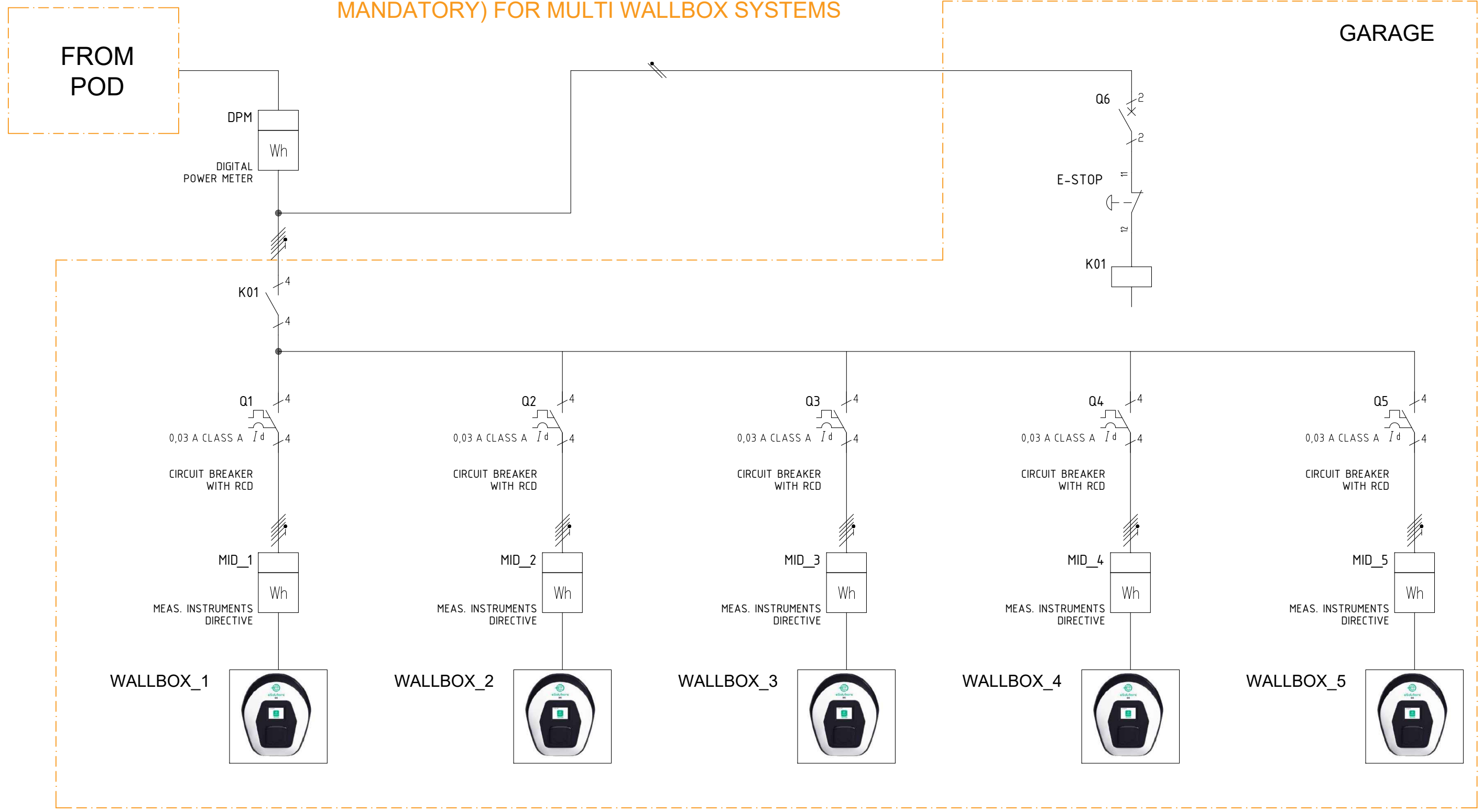

| | | | | | | | | | | | |
|------|----------|------|-------|---------|------------|--------------------------------------------------------------------------------------|-------------------------|------------------------------|--|------|-----------------|
| | | | | DATA | 06/12/2022 |  | Free2move eSolutions | Wallbox electrical diagram | | 0001 | |
| | | | | DISEGN. | FN | | | Multi Wallbox Safety Circuit | | | |
| | | | | VISTO | AS,AC,CP | | | | | | |
| REV. | MODIFICA | DATA | FIRMA | APPR. | FF | | | | | 0001 | FG. 7 F.S. / |